

CATALOG NUMBER	TYPE
PROJECT	

FLEXRAIL1™ – LINE VOLTAGE TRACK HEAD

SERIES HM1-773

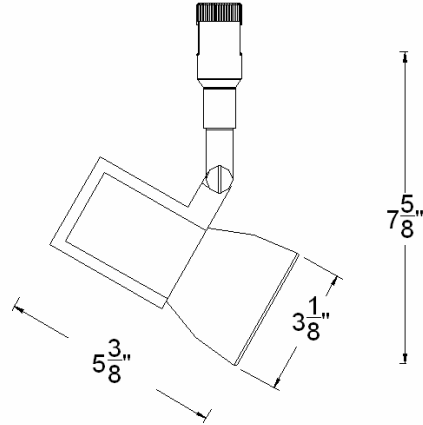

Ordering Matrix		
Series	Model	Finish
<input type="text"/>	<input type="text"/>	<input type="text"/>
HM1	773	DB PT

Ordering Example (series number – model number – finish): HM1-773-DB

Product Details	
Description:	Flexrail1™ compatible cone style line voltage track head utilizing PAR20 lamps.
Materials:	Track head and connector are die-cast aluminum. Track adaptor is polycarbonate. Medium base lamp socket is porcelain with nickel-plated copper shell.
Aiming:	350° horizontal rotation and 90° vertical aiming with integral ball and swivel mounting feature. All die-cast parts assure the aiming tension is kept through continuous use and maintenance.
Lamping:	Uses PAR20 lamp. 50W maximum.
Finish:	Abrasion resistant platinum or bronze paint finish. DB = Dark Bronze metal finish PT = Platinum metal finish
Listing:	UL & CUL Listed.

Specification Features
<ul style="list-style-type: none"> Die-cast aluminum track head with smooth aiming and contemporary design. 5 year WAC Lighting product warranty.