

CATALOG NUMBER	TYPE
PROJECT	

FLEXRAIL2 – LINE VOLTAGE TRACK HEAD **SERIES HM-738**

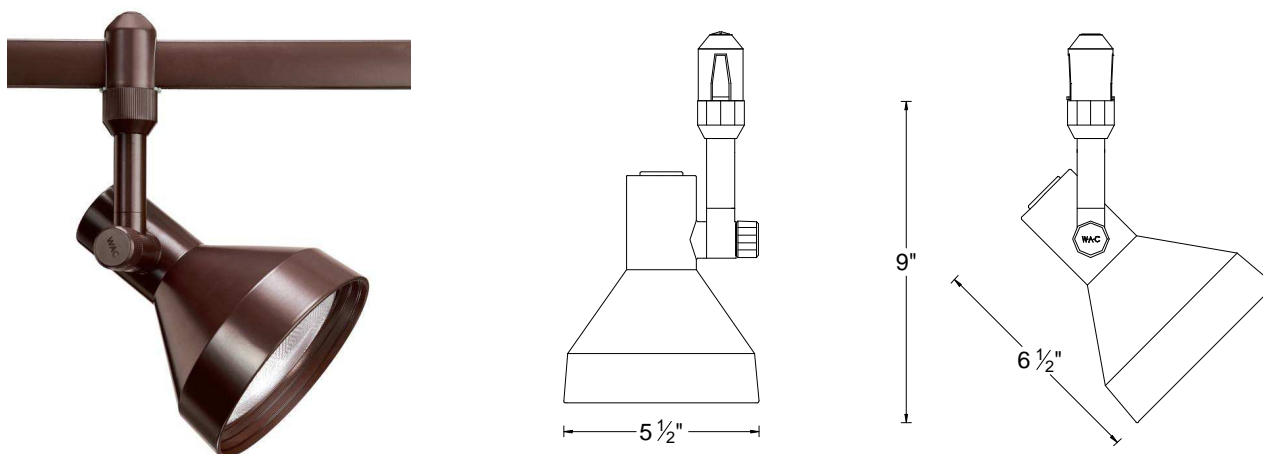

Ordering Matrix		
Series	Model	Finish
[]	[]	[]
HM	738	BZ PT

Ordering Example (series number – model number – finish): HM-738-BZ

Product Details	
Description:	Flexrail2 compatible cone style line voltage track head utilizing PAR38 lamps.
Materials:	Track head and connector are die-cast aluminum. Track adaptor is polycarbonate. Medium base lamp socket is porcelain with nickel-plated copper shell.
Aiming:	350° horizontal rotation and 90° vertical aiming with integral stem mounting feature. Locking screw assures the aiming angle is kept in place through continuous use and maintenance.
Lamping:	Uses PAR38 lamp. 150W maximum.
Finish:	Abrasion resistant platinum or bronze paint finish. BZ = Designer Bronze metal finish PT = Platinum metal finish
Listing:	UL & CUL Listed. Patent Pending.

Specification Features
<ul style="list-style-type: none"> Architectural die-cast aluminum track head with smooth aiming and contemporary design. PAR38 lamp beam spreads available in choices ranging from 8 to 60 degrees to allow for a wide variety of application specific lighting patterns. 5 year product warranty.