

INSTALLATION INSTRUCTION
826 Low Voltage LED Track Luminaires
HHT-826LED, LHT-826LED, JHT-826LED

WAC LIGHTING
Responsible Lighting®

CAUTION:

Read all instructions before installing.
Switch off power before installing or re-lamping.
Do not attempt to energize anything other than a track light fixture.
All installation shall be in accordance with NEC and all local codes.

OVERVIEW:

Fixtures are designed for use on on WAC "L", "H", "J" series track.
They may also be used on other manufacturer's brand of track
(consult factory for compatibility).

LAMPING:

1. Use 12v MR16 lamp, 50-watt max.
2. Remove the cap ring by twisting counter-clockwise.
3. Insert the MR16 lamp by aligning the pins with the holes in the ceramic socket, and pushing straight in.
4. Re-install the cap ring.

FIXTURE INSTALLATION

1. Note the track has a groove running its length to indicate polarity.
2. Note the slant of the locking tab.
3. Insert adaptor into track slot and rotate adaptor 90° so that the low side of the locking tab faces the grooved side of the track.
4. Make sure the locking tab seats in the track slot.
5. Removal is the reverse procedure. Track heads may be positioned anywhere along the track length.
6. Not suitable for use on wall mounted track.

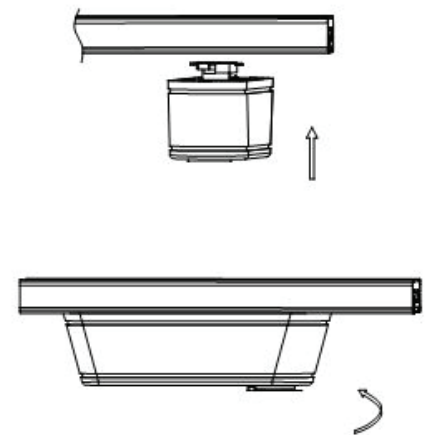
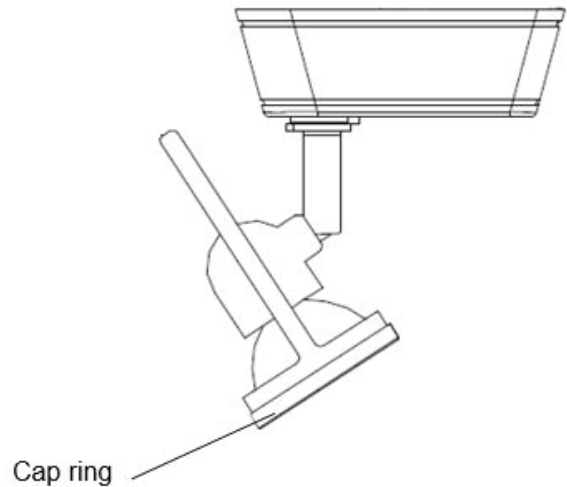

WAC Lighting
www.waclighting.com
Phone (800) 526.2588 • Fax (800) 526.2585

Headquarters/Eastern Distribution Center
44 Harbor Park Drive • Port Washington, NY 11050
Phone (516) 515.5000 • Fax (516) 515.5050

Western Distribution Center
1750 Archibald Ave • Ontario, CA 91761
Phone (800) 526.2588 • Fax (800) 526.2585